

ANYONE Onestage

by MEGA'GEN

Key Advantages

The convenience of a single prosthetic connection for all fixture size.

Compatibility of connection with many other implant system (8° Internal 3.1 Octa Connection).

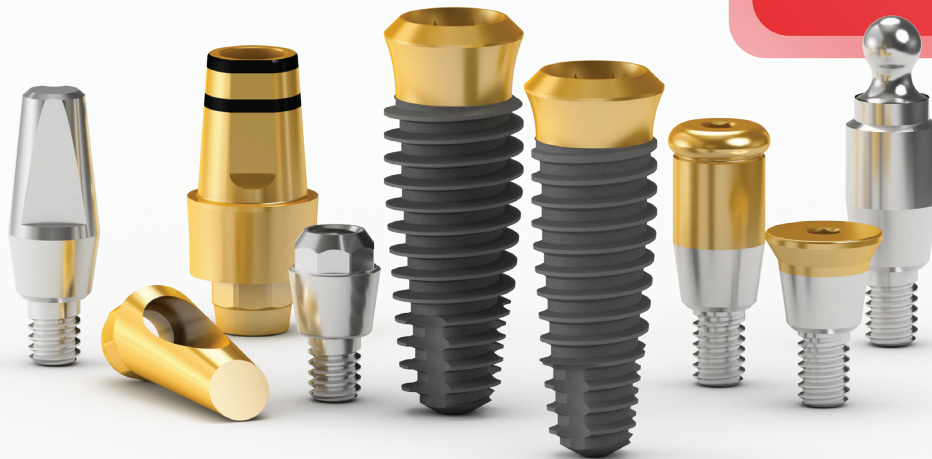

312 Characteristics & Advantages

312 I. Features

314 II. Variety of AnyOne® OneStage Fixtures

315 Fixture Product

315 I. Fixture Dimension

316 II. Fixture Size

318 Closing Screw & Cover Screw & Healing Abutment

319 Abutment & Prosthetic Options

319 I. Abutment Level Prosthesis

319 1. Solid Abutment & Components

323 2. Octa Abutment & Components

327 II. Fixture Level Prosthesis

330 III. Overdenture Prosthesis

330 1. Meg-Loc Abutment & Components

332 2. Meg-Ball Abutment & Components

334 3. Meg-Magnet Abutment & Components

336 4. Meg-Rhein Abutment & Components

* Refer to page 588 for more information on Digital Prosthesis

Characteristics & Advantages

I. Features

1. Optimum transgingival cuff enables one-stage surgery with quick restoration & precise joining of peripheral gingiva

- Anodized part is located below tissue to provide esthetic results

2. Simplified surgical protocol with predictable initial stability

- Fixture design allows easier drilling in any bone density while ensuring high initial stability

• From the smallest to the largest

Wide selection of fixture size of diameters and lengths from Ø3.5 ~ to Ø6.0, from 7mm to 15mm length adjust to all the bone condition.



3. Distributes stress on cancellous bone

- Best ISQ values due to special KnifeThread design
- Higher initial stability in any bone density due to KnifeThread super self-tapping design
- Ongoing bone condensing & ridge expansion
- Maximizes resistance to compressive force
- Minimizes production of shear force

KnifeThread®

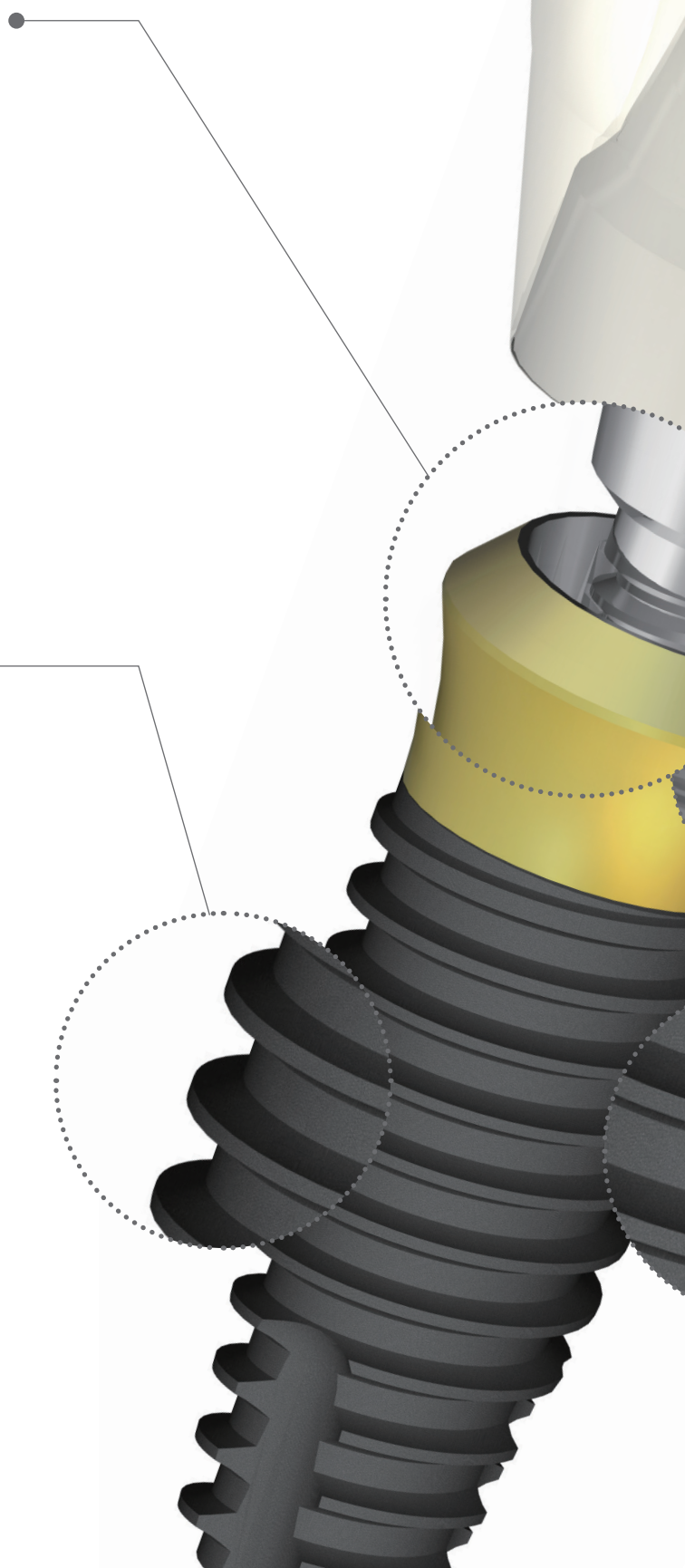
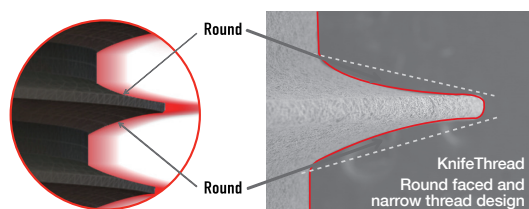

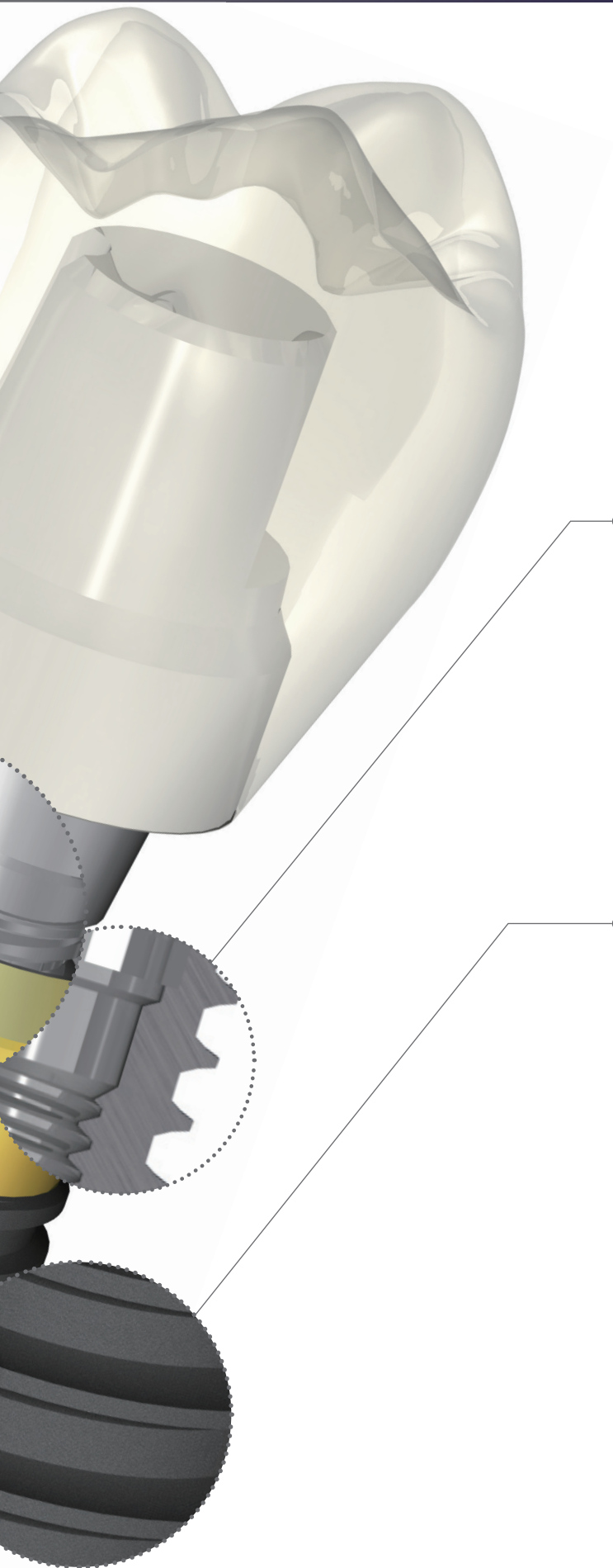

4. Convenient octa prosthetic connection for all fixture sizes with 8° internal hex connection

- Applicable to most difficult cases
- Compatible with ExFeel Internal prosthetics
- Compatible with small or regular ITI abutments

5. S-L-A surface treatment

- Ideal macro & micro roughness created via blasting & etching for excellent bone formation & morphology

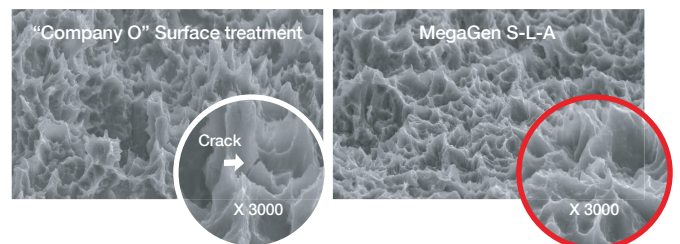

II. Variety of AnyOne® OneStage Fixtures

AnyOne has variety of choice.

1. Easy and convenient “Regular Thread”



For Hard Bone

Easy and Simple placement for all cases.

Ø3.5, Ø4.0, Ø4.5, Ø5.0

2. “Deep Thread” for stronger initial fixation



For Soft Bone

New design with extended thread gives substantially stronger initial stability for soft bone application.

Ø4.5, Ø5.0



Deep Thread

Fixture Product

I. Fixture Dimension

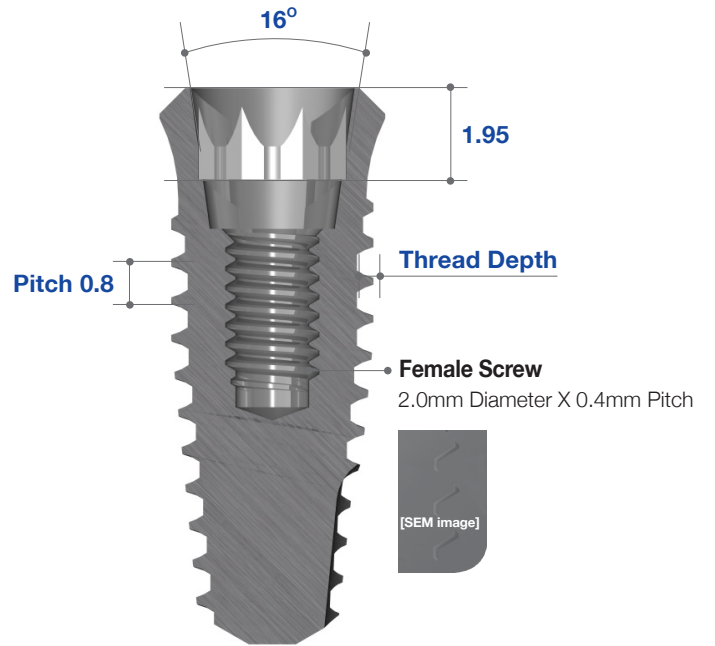
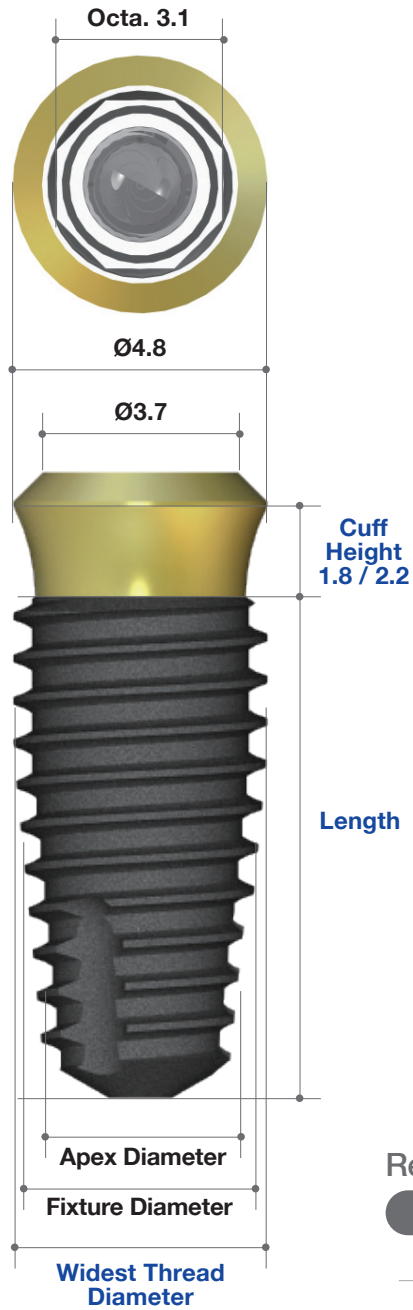

Regular Thread

Fixture Diameter	Widest-thread Diameter	Apex Diameter	Thread Depth	Real Length(mm)
Ø3.5	Ø3.9	Ø2.95	0.25	7.0 / 8 / 9.5 / 11.0 / 12.5 / 14.5
Ø4.0	Ø4.3	Ø3.4	0.35	7.0 / 8 / 9.5 / 11.0 / 12.5 / 14.5
Ø4.5	Ø4.8	Ø3.9	0.35	7.0 / 8 / 9.5 / 11.0 / 12.5 / 14.5
Ø5.0	Ø5.3	Ø4.4	0.35	7.0 / 8 / 9.5 / 11.0 / 12.5 / 14.5

(Excluding length 7 & 8.5)

Deep Thread

Fixture Diameter	Widest-thread Diameter	Apex Diameter	Thread Depth	Real Length(mm)
Ø4.5	Ø4.8	Ø3.9	0.6	7.0 / 8 / 9.5 / 11.0 / 12.5 / 14.5
Ø5.0	Ø5.3	Ø4.4	0.85	7.0 / 8 / 9.5 / 11.0 / 12.5 / 14.5

(Excluding length 7 & 8.5)

II. Fixture Size

Regular Thread Ø3.5

- Healing Abutment(IRH503) included

Diameter (mm)	Length (mm)	Cuff Height (mm)	Ref.C
Ø3.5	7.0	1.8	OSF3507H
		2.2	OSF3507LH
	8.5	1.8	OSF3508H
		2.2	OSF3508LH
	10.0	1.8	OSF3510H
		2.2	OSF3510LH
	11.5	1.8	OSF3511H
		2.2	OSF3511LH
	13.0	1.8	OSF3513H
		2.2	OSF3513LH
	15.0	1.8	OSF3515H
		2.2	OSF3515LH

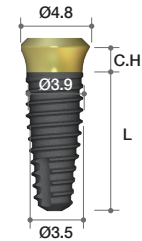

Regular Thread Ø4.0

- Healing Abutment(IRH503) included

Diameter (mm)	Length (mm)	Cuff Height (mm)	Ref.C
Ø4.0	7.0	1.8	OSF4007H
		2.2	OSF4007LH
	8.5	1.8	OSF4008H
		2.2	OSF4008LH
	10.0	1.8	OSF4010H
		2.2	OSF4010LH
	11.5	1.8	OSF4011H
		2.2	OSF4011LH
	13.0	1.8	OSF4013H
		2.2	OSF4013LH
	15.0	1.8	OSF4015H
		2.2	OSF4015LH

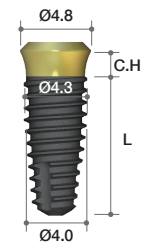

Regular Thread Ø4.5

- Healing Abutment(IRH503) included

Diameter (mm)	Length (mm)	Cuff Height (mm)	Ref.C
Ø4.5	7.0	1.8	OSF4507H
		2.2	OSF4507LH
	8.5	1.8	OSF4508H
		2.2	OSF4508LH
	10.0	1.8	OSF4510H
		2.2	OSF4510LH
	11.5	1.8	OSF4511H
		2.2	OSF4511LH
	13.0	1.8	OSF4513H
		2.2	OSF4513LH
	15.0	1.8	OSF4515H
		2.2	OSF4515LH

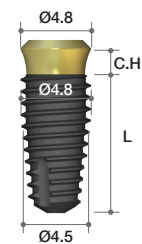

Regular Thread Ø5.0

- Healing Abutment(IRH503) included

Diameter (mm)	Length (mm)	Cuff Height (mm)	Ref.C
Ø5.0	7.0	1.8	OSF5007H
		2.2	OSF5007LH
	8.5	1.8	OSF5008H
		2.2	OSF5008LH
	10.0	1.8	OSF5010H
		2.2	OSF5010LH
	11.5	1.8	OSF5011H
		2.2	OSF5011LH
	13.0	1.8	OSF5013H
		2.2	OSF5013LH
	15.0	1.8	OSF5015H
		2.2	OSF5015LH

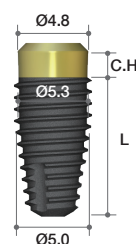

Deep Thread Ø4.5

- Healing Abutment(IRH503) included

Diameter (mm)	Length (mm)	Cuff Height (mm)	Ref.C
Ø4.5	7.0	1.8	OSF4507DH
		2.2	OSF4507LDH
	8.5	1.8	OSF4508DH
		2.2	OSF4508LDH
	10.0	1.8	OSF4510DH
		2.2	OSF4510LDH
	11.5	1.8	OSF4511DH
		2.2	OSF4511LDH
	13.0	1.8	OSF4513DH
		2.2	OSF4513LDH
	15.0	1.8	OSF4515DH
		2.2	OSF4515LDH

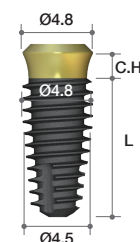

Deep Thread Ø5.0

- Healing Abutment(IRH503) included

Diameter (mm)	Length (mm)	Cuff Height (mm)	Ref.C
Ø5.0	7.0	1.8	OSF5007DH
		2.2	OSF5007LDH
	8.5	1.8	OSF5008DH
		2.2	OSF5008LDH
	10.0	1.8	OSF5010DH
		2.2	OSF5010LDH
	11.5	1.8	OSF5011DH
		2.2	OSF5011LDH
	13.0	1.8	OSF5013DH
		2.2	OSF5013LDH
	15.0	1.8	OSF5015DH
		2.2	OSF5015LDH

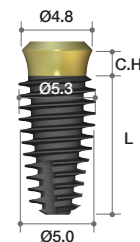

Closing Screw & Cover Screw & Healing Abutment

Closing Screw

- Used for two stage surgical protocol.
- Protects the inner portion and platform of the fixture after placing.
- Uses Hand Driver (1.2 Hex).
- Recommend torque : by hand (5 - 8Ncm)

Diameter(mm)	Height(mm)	Ref.C
Ø3.5	1.5	ICS200

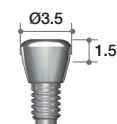

Cover Screw

- Used for two stage surgical protocol.
- Protects the inner portion and platform of the fixture after placing.
- Uses Hand Driver (1.2 Hex).
- Recommend torque : by hand (5 - 8Ncm)

Diameter(mm)	Height(mm)	Ref.C
Ø5.8	1.5	IRC100

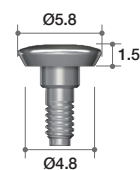

Healing Abutment

- Creates the emergence profile of the gingival tissue during healing.
- Uses Hand Driver (1.2 Hex).
- Recommend torque : by hand (5 - 8Ncm)

Diameter(mm)	Height(mm)	Ref.C
Ø5.8	2.0	IRH502
	3.0	IRH503
	4.0	IRH504

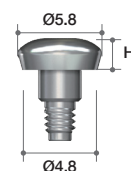

Abutment & Prosthetic Options

I. Abutment Level Prosthesis

1. Solid Abutment & Components

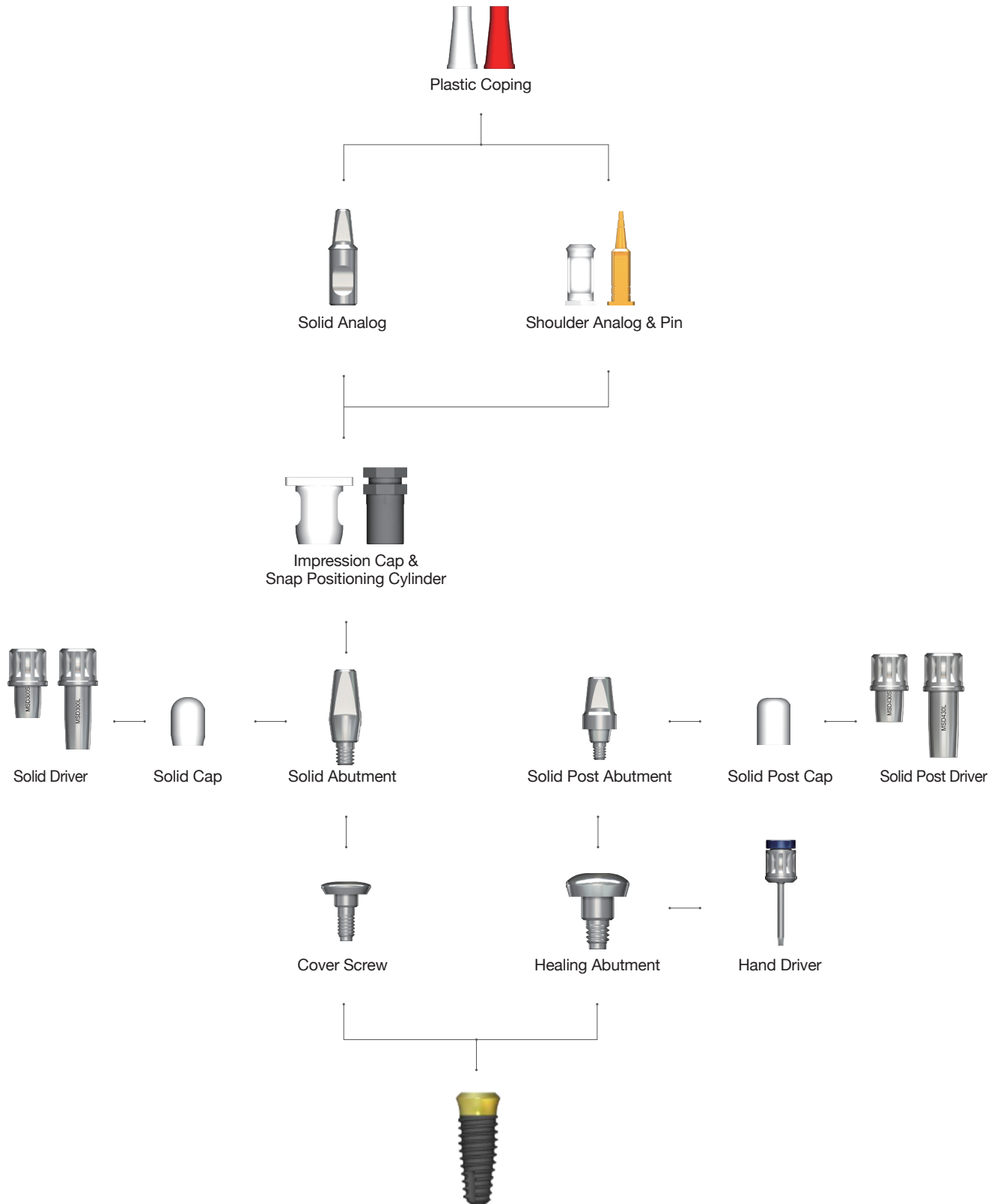

►► Impression Technique with Solid Type

Solid Abutment

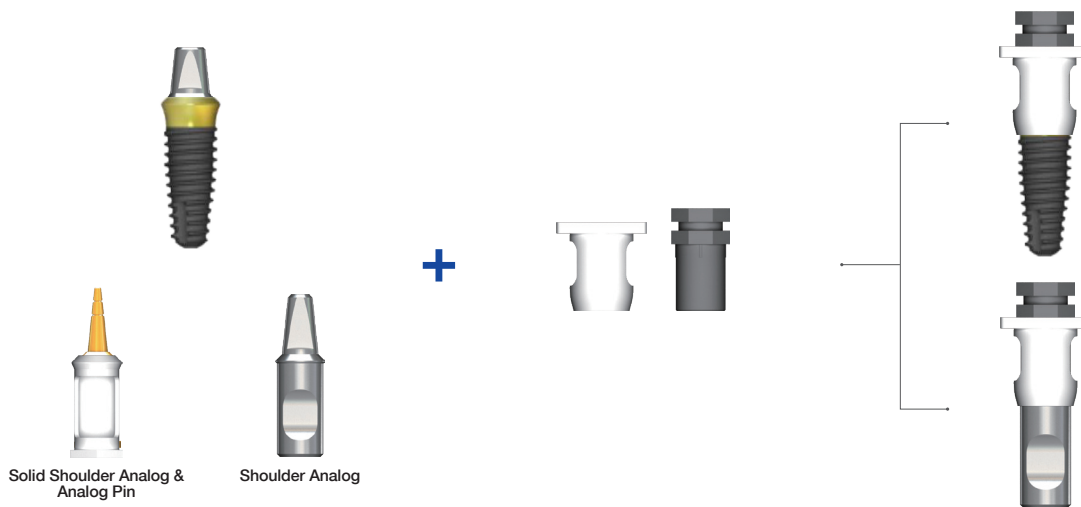

• **Solid Abutment**

- After the solid abutment is placed in the oral cavity, take an impression by using the Solid Impression Cap and the Solid Positioning Cylinder.
- If Solid Abutment is not prepared, use the Solid Level Analog. However if it's prepared, use the Analog Pin and the Solid Shoulder Analog for accurate impression.

Solid Post Abutment



• **Solid Post Abutment**

- Taking impression of the Solid Post Abutment follows the general method of rubber impression and production of a work model.

➔ Components for Solid Abutment (Continued)

Solid Abutment

- Solid Cap included

- Cement retained restoration only.
- Solid Abutment should be placed into patient's mouth before taking impression.
- Should be tightened with Solid Driver and Hand Driver.
- Recommend Torque : 35Ncm
- Post Height : 4.0, 5.5, 7.0mm

Profile Diameter	Post Height(mm)	Ref.C
Ø3.5	4.0	ISA400P
	5.5	ISA550P
	7.0	ISA700P

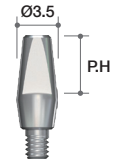

Solid Cap

- Protects a Solid Abutment and minimizes irritation to tongue and oral mucosa
- Easily make a temporary crown by resin build up
- Post Height : 4.0, 5.5, 7.0mm

Profile Diameter	Post Height(mm)	Ref.C
Ø5.7	4.0	ISPC450
	5.5	ISPC600
	7.0	ISPC750

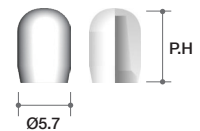

Solid Post Abutment

- Solid Post cap included

- Cement retained restoration only.
- Solid Abutment should be placed into patient's mouth before taking impression.
- Should be tightened with Solid Driver and Hand Driver.
- Recommend Torque : 35Ncm
- Post Height : 4.0, 5.5, 7.0mm
- Cuff Height : 1, 2, 3mm

Profile Diameter	Cuff Height(mm)	Post Height(mm)	Ref.C
Ø4.9	1	4.0	ISPA401P
	2		ISPA402P
	3		ISPA403P
	1	5.5	ISPA551P
	2		ISPA552P
	3		ISPA553P
	1	7.0	ISPA701P
	2		ISPA702P
	3		ISPA703P

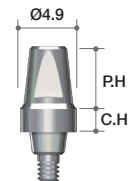

Solid Post Cap

- Protects a Solid Abutment and minimizes irritation to tongue and oral mucosa
- Easily make a temporary crown by resin build up
- Post Height : 4.0, 5.5, 7.0mm
- Cuff Height : 1, 2, 3mm

Profile Diameter	Cuff Height(mm)	Post Height(mm)	Ref.C
Ø5.3	1	4.0	ISPC401
	2		ISPC402
	3		ISPC403
	1	5.5	ISPC551
	2		ISPC552
	3		ISPC553
	1	7.0	ISPC701
	2		ISPC702
	3		ISPC703

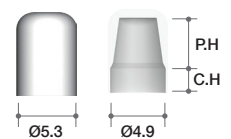

➔ Components for Solid Abutment

Solid Analog

- Impression components used when removing Solid Abutment Shoulder Analog

Profile Diameter	Post Diameter	Post Height(mm)	Ref.C
Ø4.8	Ø3.5	4.0	ISN400
		5.5	ISN550
		7.0	ISN700

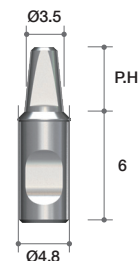

Positioning Cylinder

- Can be engaged with Solid Abutment in impression

Height(mm)	Ref.C
9.2	IIPC100

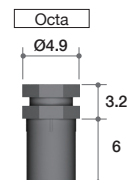

Impression Cap

- Impression components used when removing Solid Abutments

Profile Diameter	Ref.C
Ø5.7	ISIC100



Shoulder Analog

- Impression components used when removing Solid Abutment
- Implement the platform part of the fixture in the process of modeling

Profile Diameter	Post Height(mm)	Ref.C
Ø4.8	10	ISLA100

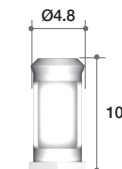

Shoulder Analog Pin

- Impression components used when removing Solid Abutment
- Can be engaged with Sold Shoulder Analog
- Components to prevent from fracturing in the process of modeling

Profile Diameter	Post Height(mm)	Ref.C
Ø3.5	7	ISLA200

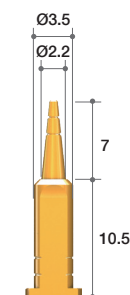

Plastic Coping

- Precisely plugged into post portion of Solid Abutment, Solid Post Abutment, and Lab Analog
- Offers easy wax up and accurate margins / clean burnout

Profile Diameter	Post Height(mm)	Type	Ref.C
Ø5.0	10.0	Single	ISPS100
		Bridge	ISPB100

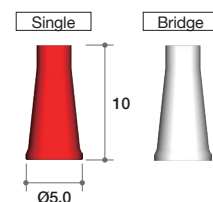

I. Abutment Level Prosthesis

2. Octa Abutment & Components

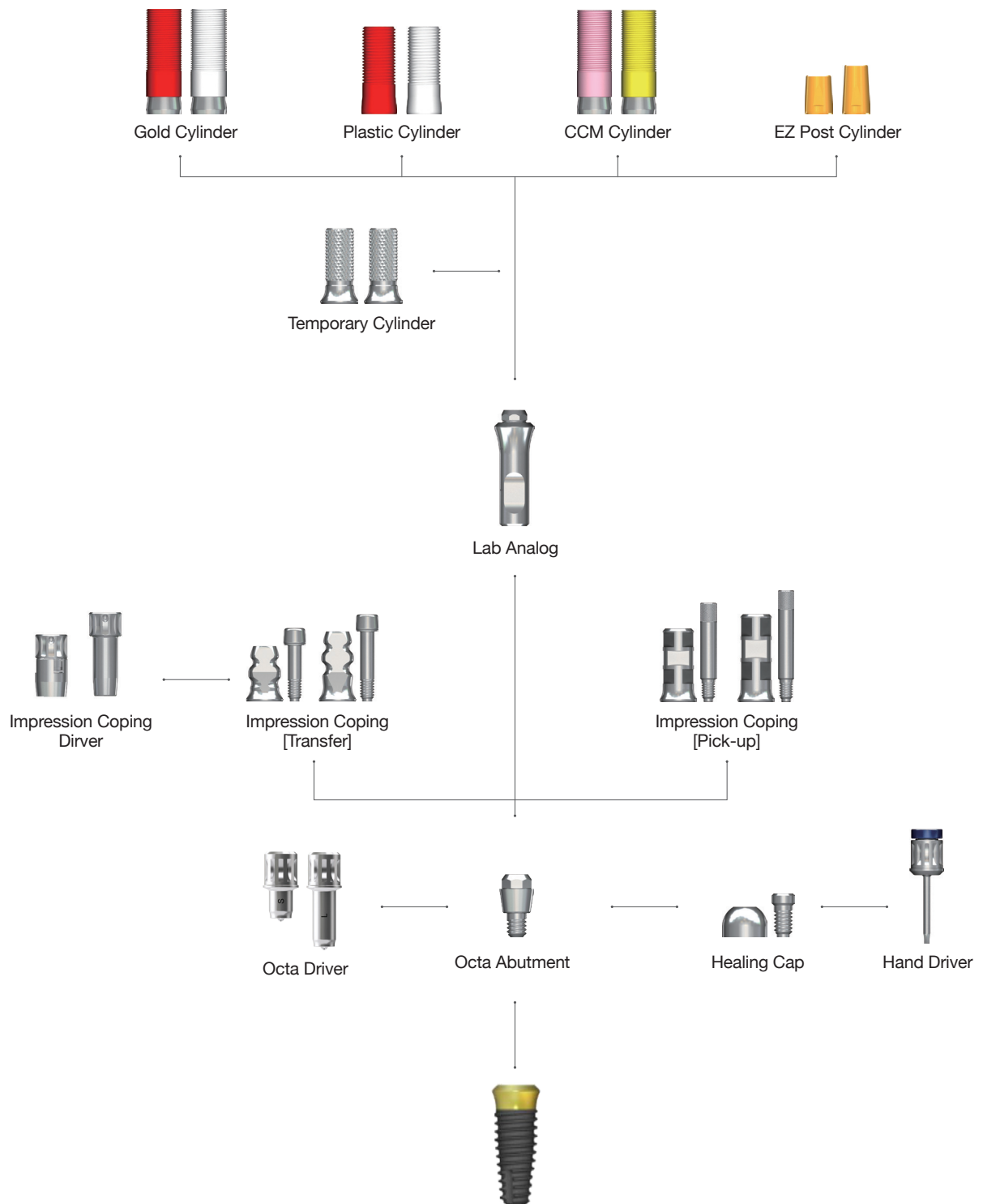

➔ Components for Octa Abutment (Continued)

Octa Abutment

- Used to make multiple screw-retained prosthetics.
- Recommend Torque : 35Ncm

Profile Diameter	Ref.C
Ø3.5	IOA200

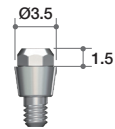

Healing Cap

- Cylinder Screw (IRCS200) included
- Protects Octa Abutment and minimizes irritation to tongue and oral mucosa.

Profile Diameter	Ref.C
Ø5.0	IHC400T



Impression Coping (Transfer)

- Guide Pin included
- Fasten with Impression Driver
- Can purchase the Guide Pin that can be tightened with 1.2mm Hex Driver separately

Profile Diameter	Height (mm)	Type	Ref.C
Ø5.0	7.5	Octa	AAOITO5010T
		Non-Octa	AAOITN5010T
	9.5	Octa	AAOITO5012T
		Non-Octa	AAOITN5012T

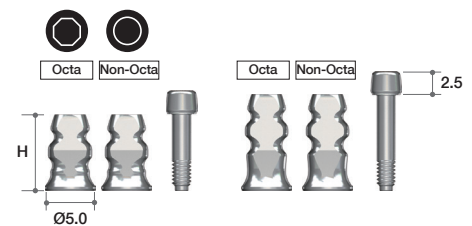

Impression Coping (Pick-up)

- Guide Pin included

Profile Diameter	Height (mm)	Type	Ref.C
Ø5.0	10.0	Octa	AAOIPO5010T
		Non-Octa	AAOIPN5010T
	12.0	Octa	AAOIPO5012T
		Non-Octa	AAOIPN5012T

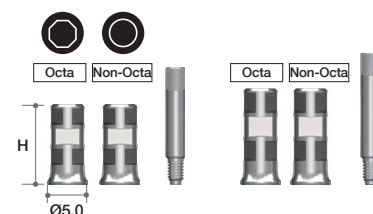

Lab Analog

- Use it with Snap Impression Coping in Impression which acquired when you create the Stone Model

Profile Diameter	Ref.C
Ø4.8	IOA300

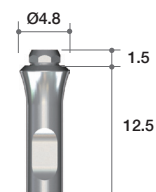

Temporary Cylinder

- Cylinder Screw (IRCS200) included
- Recommend torque : 25Ncm

Profile Diameter	Type	Ref.C
Ø5.0	Octa	AAOTCO5010T
	Non-Octa	AAOTCN5010T

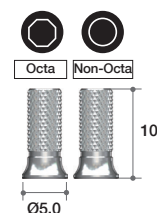

EZ Post Cylinder

- Cylinder Screw (IRCS200) included
- Recommend torque : 35Ncm

Profile Diameter	Post Height(mm)	Type	Ref.C
Ø5.0	5.5	Octa	AAOECO5005T
	7.0		AAOECO5007T
	5.5	Non-Octa	AAOECN5005T
	7.0		AAOECN5007T

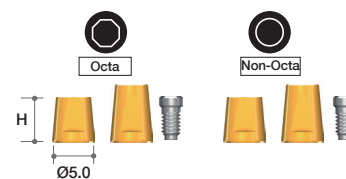

➔ Components for Octa Abutment

Gold Cylinder

- Cylinder Screw (IRCS200) included

- For customizing abutment for screw retained multi-unit restoration.
 - Available in both octa(red) and non-octa(white)
- Melting point of gold alloy : 1063°C
- Threaded sleeves allow for better retention of resin or wax.
- Recommend torque : 30Ncm

Profile Diameter	Type	Ref.C
Ø5.0	Octa	IOGO100T
	Non-Octa	IIGN100T

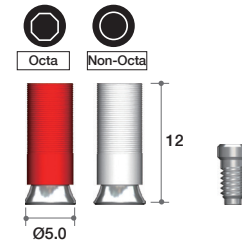

CCM Cylinder

- Cylinder Screw (IRCS200) included

- Threaded sleeves allow for better retention of resin or wax
- Octa(Pink), Non-Octa(Yellow)
- Melting temperature of CCM base: 1300~1400°C
- Recommend torque : 35Ncm
- Can be casted with non-precious alloys (Ni-Cr, Cr-Co alloys).

Profile Diameter	Type	Ref.C
Ø5.0	Octa	AANCCO5000T
	Non-Octa	AANCCN5000T

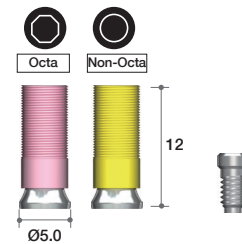

Plastic Cylinder

- Cylinder Screw (IRCS200) included

- Economical option
- For customizing abutment for screw retained multi-unit restoration
- Available in both octa(red) and non-octa(white)
- Threaded sleeves allow for better retention of resin or wax.
- Recommend torque : 25Ncm

Profile Diameter	Type	Ref.C
Ø5.0	Octa	IOPH100T
	Non-Octa	IOPN100T

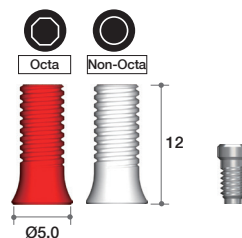

II. Fixture Level Prosthesis

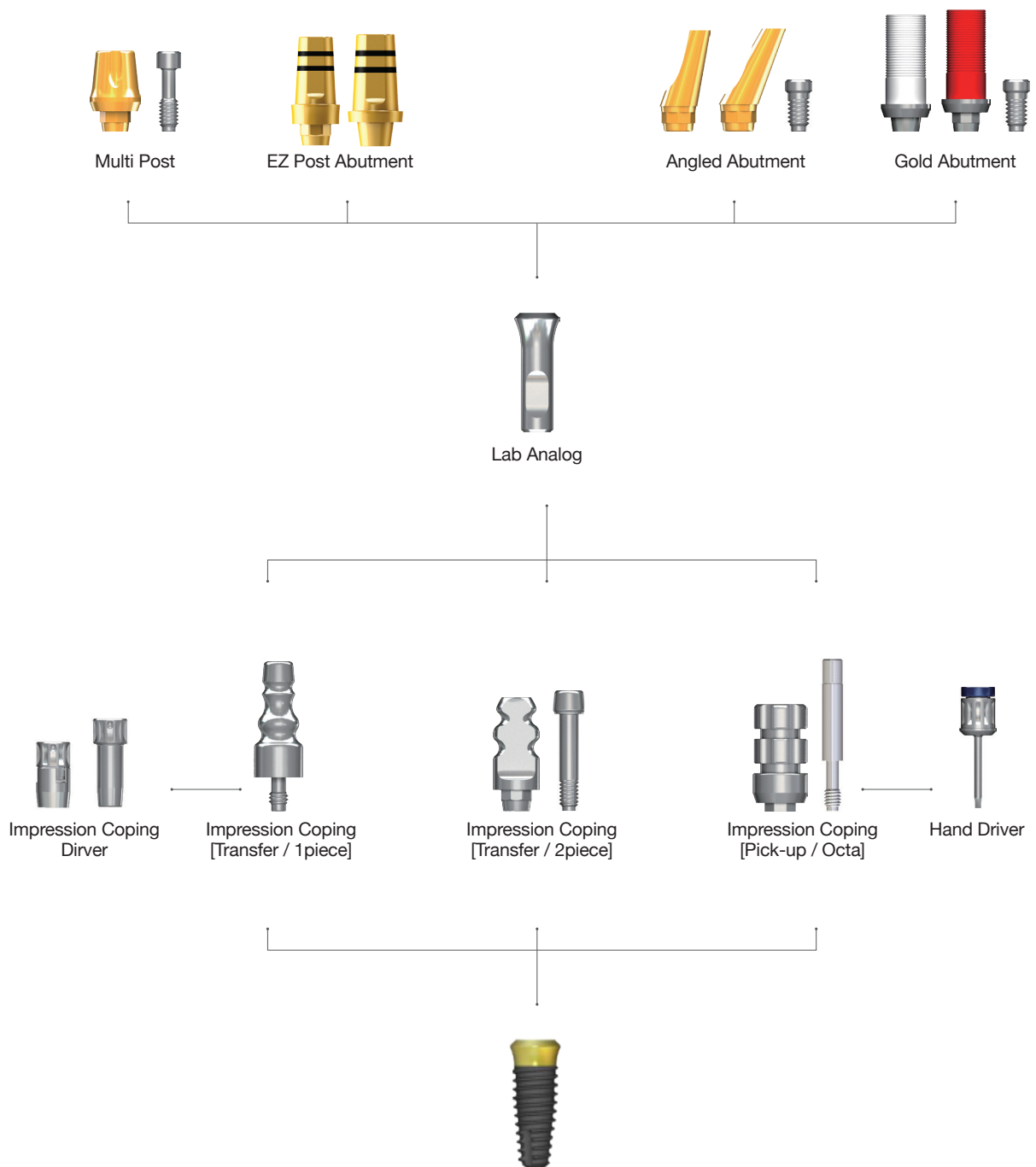

➔ Abutment Options

Impression Coping (Transfer Type)

- 2 Piece Type and Guide Pin (REIG150) included
- One Piece(Non-Octa), Two Piece(Octa)
- 2 Different Heights
- Used for Closed Tray(Transfer) Technique
- Easy & Accurate Fixture Position Transfer
- Flat Surface fits well with the Hex in the Fixture
- Use Transfer Impression Coping driver and Hand Driver (1.2 hex) to tighten Impression Coping accurately
- Guide Pin which should be tightening by 1.2 Hex Driver can be purchased separately

Profile Diameter	Height (mm)	Type	Ref.C
Ø4.8	12	1 Piece	EITN5012
	16		EITN5016
	12		EITN5012H
	16		EITN5016H
	9.5	2 Piece	EIIT05012T
	13.5		EIIT05016T
	9.5		EIIT05012HT
	13.5		EIIT05016HT

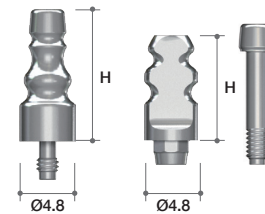

Impression Coping (Pick-up Type)

- Guide Pin (EXICG100) included
- Recommended to use for multiple case
- Square Body Design guarantees stability with in the impression and transfers the fixture position accurately
- Guide Pin which should be tightening by 1.2 Hex Driver can be purchased separately

Profile Diameter	Height (mm)	Type	Ref.C
Ø5.5	10	Octa	EXIC001T

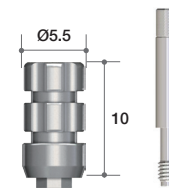

Lab Analog

- Used instead of Fixture in Impression

Profile Diameter	Ref.C
Ø4.8	EXIA001



Multi Post

- Multi Post Screw (EXIMS100) included
- Cement Retained Restoration
- Post Height : 6.5mm
- The anodizing part is located below the Tissue to provide an aesthetic design
- Recommended Torque : 35Ncm

Diameter	Height(mm)	Ref.C
Ø5.5	6.5	EXIM001T

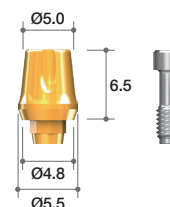

Multi Post Cap

- Protects Multi Post and minimizes discomfort of oral cavity

Height(mm)	Ref.C
5.7	EXIMC100



EZ Post Abutment

- Multi Post Screw(EXIMS100) included.
- Use with a Hand Driver (1.2 Hex).
- Esthetic gold coloring.
- Three different post heights. (4.0, 5.5, 7.0mm)
- Four different cuff heights. (0, 1.0, 2.0, 3.0mm)
- Recommend torque : 35Ncm

Profile Diameter	Cuff Height (mm)	Post Height (mm)	Type	Ref.C
Ø5.0	0.0	4.0	Octa	AOOEP05004T
	1.0			AOOEP05014T
	2.0			AOOEP05024T
	3.0			AOOEP05034T
	0.0	5.5		AOOEP05005T
	1.0			AOOEP05015T
	2.0			AOOEP05025T
	3.0			AOOEP05035T
	0.0	7.0		AOOEP05007T
	1.0			AOOEP05017T
	2.0			AOOEP05027T
	3.0			AOOEP05037T
Ø5.0	0.0	4.0	Non-Octa	AOOEPN5004T
	1.0			AOOEPN5014T
	2.0			AOOEPN5024T
	3.0			AOOEPN5034T
	0.0	5.5		AOOEPN5005T
	1.0			AOOEPN5015T
	2.0			AOOEPN5025T
	3.0			AOOEPN5035T
	0.0	7.0		AOOEPN5007T
	1.0			AOOEPN5017T
	2.0			AOOEPN5027T
	3.0			AOOEPN5037T

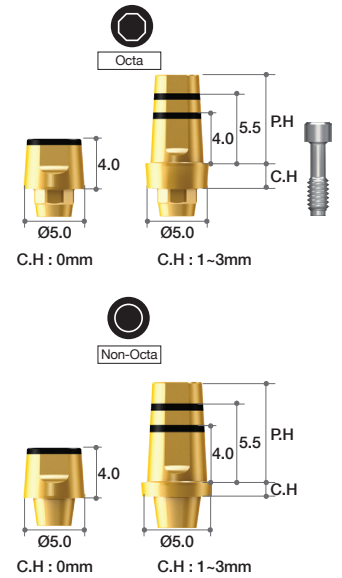

Angled Abutment

- Abutment Screw (IAAS600) included
- Two different angulations. (15°, 25°)
- Minimized screw head length needs minimum height to prevent milling problems
- Recommended Torque : 35Ncm

Profile Diameter	Height (mm)	Angle	Ref.C
Ø3.7	6.5	15°	IAA3515T
		25°	IAA3525T

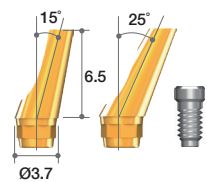

Gold Abutment

- Abutment Screw(EXIMS100) included
- Useful to make a customized abutment in difficult situations
- Octa(Red) and Non-Octa(White)
- Melting point of gold alloy : 1063°C
- Threaded sleeves allow for better retention of resin or wax
- Recommended Torque : 30Ncm

Profile Diameter	Sleeve Color Vision	Type	Ref.C
Ø5.5	White	Non-Octa	EXIGA100T
	Red	Octa	EXIGA200T

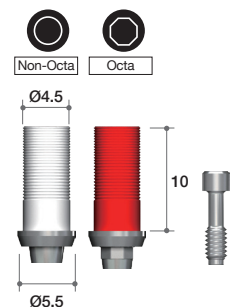

III. Overdenture Prosthesis

1. Meg-Loc Abutment & Components



Meg-Loc Metal Housing set



Block-out Spacer



Meg-Loc Abutment



➔ Meg-Loc Overdenture System

(Refer to the advantage of Meg-Loc overdenture system on page.146)

Meg-Loc Abutment

- Angle compensation to one side 20 ° (both sides 40 °)
- Gently rounded shape
- Compatible with 1.2 Hex Driver
- Recommend torque : 35Ncm

Cuff Height (mm)	Ref.C
0	MLOO00
1.0	MLOO01
2.0	MLOO02
3.0	MLOO03
4.0	MLOO04
5.0	MLOO05
6.0	MLOO06
7.0	MLOO07

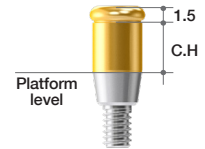

Meg-Loc Package

- 1 Meg-Loc Abutment

* Following package items are delivered with San DreMetto Korea packaging.

- 1 Titanium Housing
- 1 Block Out Spacer
- 4 Pekkton Retention Inserts (Gray-600gf(for lab), Yellow-1000gf, Red-1200gf, Mint-1800gf)

Cuff Height (mm)	Ref.C
0	MLOO00P
1.0	MLOO01P
2.0	MLOO02P
3.0	MLOO03P
4.0 </td <td>MLOO04P</td>	MLOO04P
5.0	MLOO05P
6.0	MLOO06P
7.0	MLOO07P



Meg-Loc Attachment

Description	QTY	Ref.C
CM-LOC Attachment	SET	CM-LOC
Housing Titanium® for Pekkton® Inserts	4EA	CM-LOC-TP
Processing Insert (extra-low)	4EA	CM-LOC-PI
Insert (extra-low)	4EA	CM-LOC-EL
Insert (low)	4EA	CM-LOC-L
Insert (medium)	4EA	CM-LOC-M
Block-out Spacer	4EA	CM-LOC-BS
Impression Part	4EA	CM-LOC-IP
Analog	4EA	CM-LOC-AN

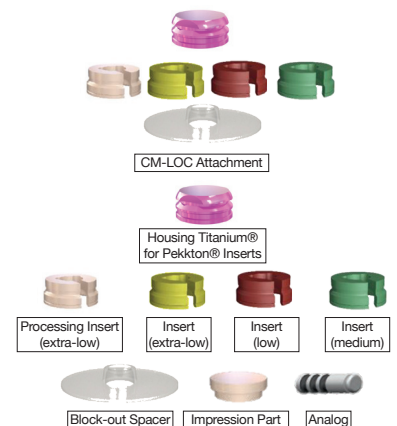

Multi Tool

- Retention insert Insert & Remove Tool

Ref.C
MLMT

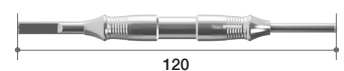

III. Overdenture Prosthesis

2. Meg-Ball Abutment & Component

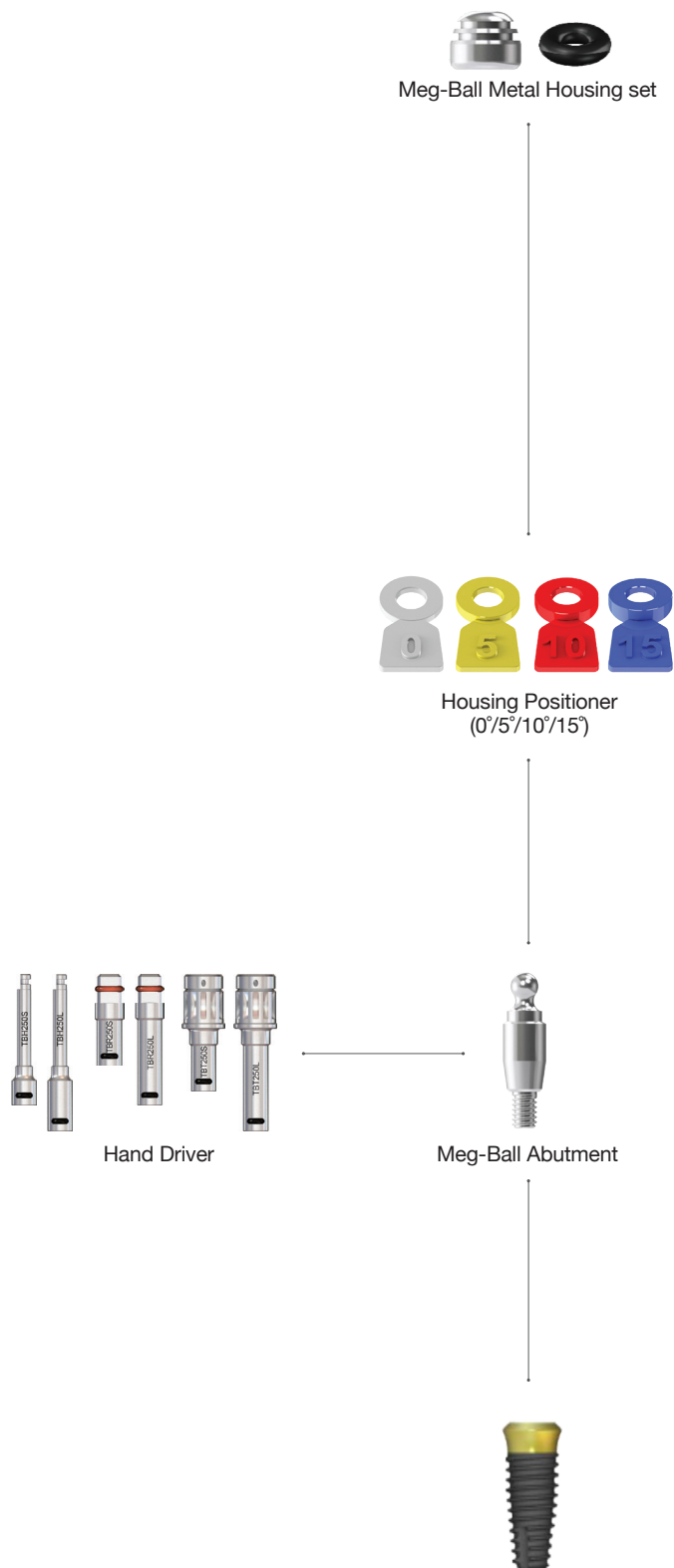

➔ Meg-Ball Overdenture System

(Refer to the advantage of Meg-Ball overdenture system on page.149)

Meg-Ball Abutment

- Angle compensation to one side 15° (both sides 30°)
- Ø2.25 Ball shape
- Recommend torque : 35Ncm

Cuff Height (mm)	Ref.C
0	MBOO00
1.0	MBOO10
2.0	MBOO20
3.0	MBOO30
4.0	MBOO40
5.0	MBOO50
6.0	MBOO60
7.0	MBOO70

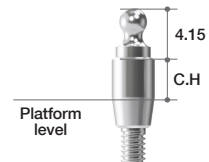

Meg-Ball Package

- Composed of Meg-Ball Abutment/ Metal Housing Set/ Housing Positioner (0°,5°,10°,15°)

Cuff Height (mm)	Ref.C
0	MBOO00P
1.0	MBOO10P
2.0	MBOO20P
3.0	MBOO30P
4.0	MBOO40P
5.0	MBOO50P
6.0	MBOO60P
7.0	MBOO70P



Meg-Ball Metal Housing Set

- 1 Metal Housing
- 1 Retentive Ring

Ref.C
MBHR



Retentive Ring Set

- MBR5 = 5ea
- MBR10 = 10ea

Quantity	Ref.C
5	MBR5
10	MBR10



Ball Driver

- For seating of the Ball Abutment into the fixture.
- Can connect to a Handpiece, Ratchet or Torque Wrench.
- Available in long and short.
- Refer to Page. 425

Type	Ref.C
Toque Driver(Short)	TBT250S
Toque Driver(Long)	TBT250L

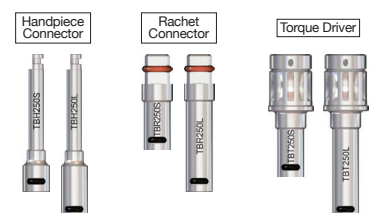

III. Overdenture Prosthesis

3. Meg-Magnet Abutment & Component



Magnet
(Small / Regular)



Magnetic Positioner
(Small / Regular)



Magnetic Abutment



➔ Meg-Magnet Overdenture System

(Refer to the advantage of Meg-Magnet overdenture system on page.152)

Meg-Magnet Abutment

- Use to 1.2 Hex Driver
- Recommend torque : 35Ncm

Profile Diameter	Cuff Height (mm)	Ref.C
Ø4.5	0.0	MMOO400
	1.0	MMOO410
	2.0	MMOO420
	3.0	MMOO430
	4.0	MMOO440
	5.0	MMOO450
	6.0	MMOO460
Ø5.0	7.0	MMOO470
	0.0	MMOO500
	1.0	MMOO510
	2.0	MMOO520
	3.0	MMOO530
	4.0	MMOO540
	5.0	MMOO550
	6.0	MMOO560
	7.0	MMOO570

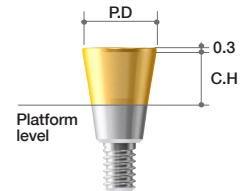

Meg-Magnet Package

- 1 Meg-Magnet Abutment
- 1 Magnet (Ø4.5-S, Ø5.0-R)
- 1 Magnetic Positioner

***Caution!**

[Magnetic Positioner]

- Use according to the standard
- : Small(White)/ Regular(Green)
- Do not reuse

[Magnet]

- Do not heat above 70°C
- : Loss of magnetism at high temperatures
- : If sterilization is required, alcohol disinfection is recommended, not autoclave
- Remove if taking MRI.
- No direct contact between products during the procedure
- : Difficulty in separation due to attraction between magnets

Profile Diameter	Cuff Height (mm)	Ref.C
Ø4.5	0.0	MMOO400P
	1.0	MMOO410P
	2.0	MMOO420P
	3.0	MMOO430P
	4.0	MMOO440P
	5.0	MMOO450P
	6.0	MMOO460P
Ø5.0	7.0	MMOO470P
	0.0	MMOO500P
	1.0	MMOO510P
	2.0	MMOO520P
	3.0	MMOO530P
	4.0	MMOO540P
	5.0	MMOO550P
	6.0	MMOO560P
	7.0	MMOO570P



Meg-Magnet Attachment Set

Size	Ref.C
Small	MA402
Regular	MA502

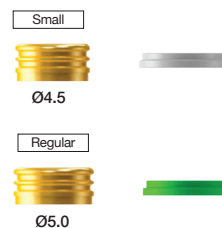

III. Overdenture Prosthesis

4. Meg-Rhein Abutment & Components

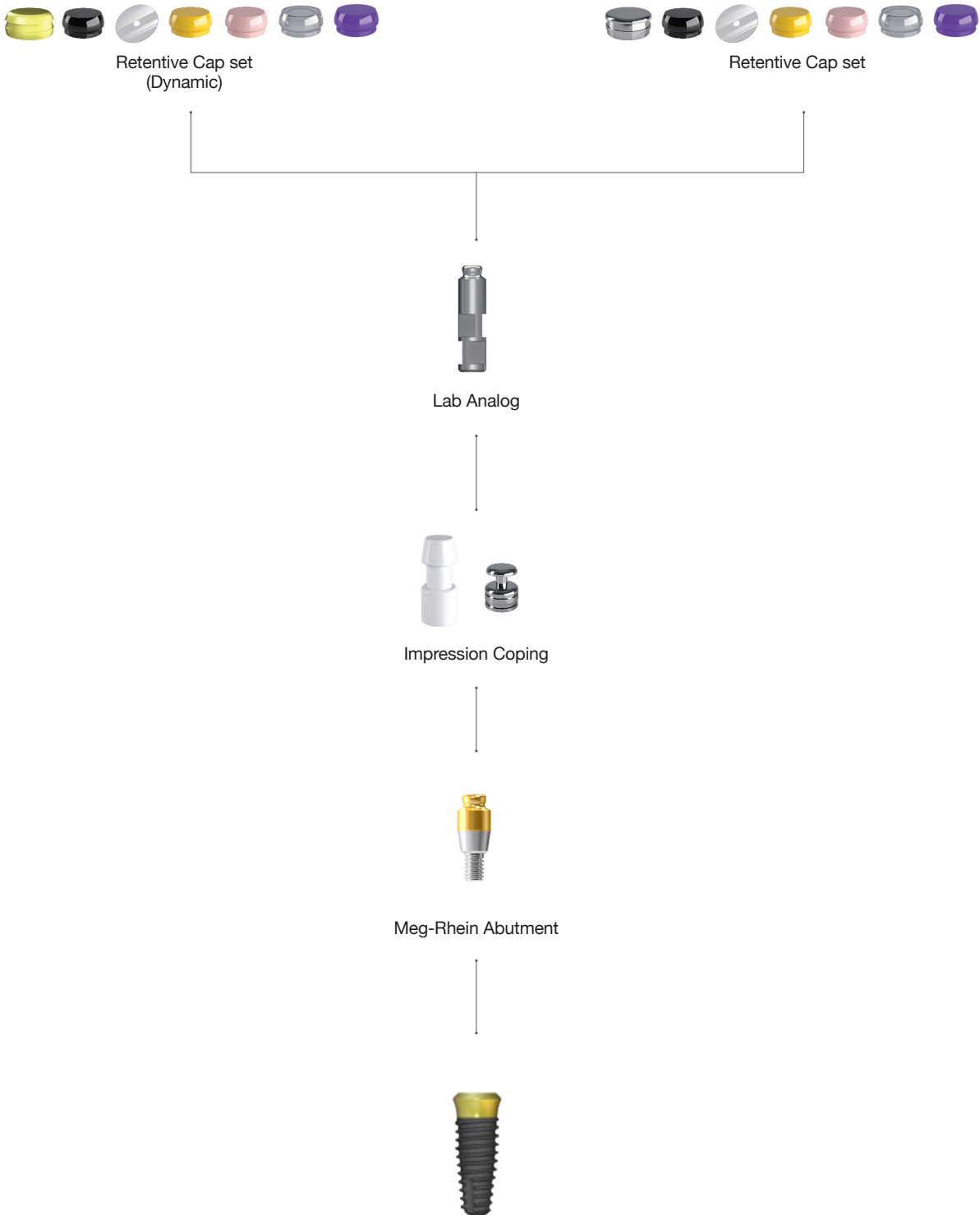

➔ Meg-Rhein Overdenture System

(Refer to the advantage of Meg-Rhein overdenture system on page.156)

Meg-Rhein Overdenture System (Dynamic)

- 1 Meg-Rhein Abutment
- 1 Plastic Impression Coping
- 1 Stainless Steel Housing (Dynamic) & Black-Lab
- 1 Protective Disk
- 4 Retentive Caps (Yellow-0.6kgf, Pink-1.2kgf, White-1.8kgf, Violet-2.7kgf)
- Perfect compatibility with the Rhein83 from Italy.
- Recommend torque : 35Ncm.

Cuff Height (mm)	Ref.C
0	IDR00PA
2.0	IDR02PA
4.0	IDR04PA
6.0	IDR06PA

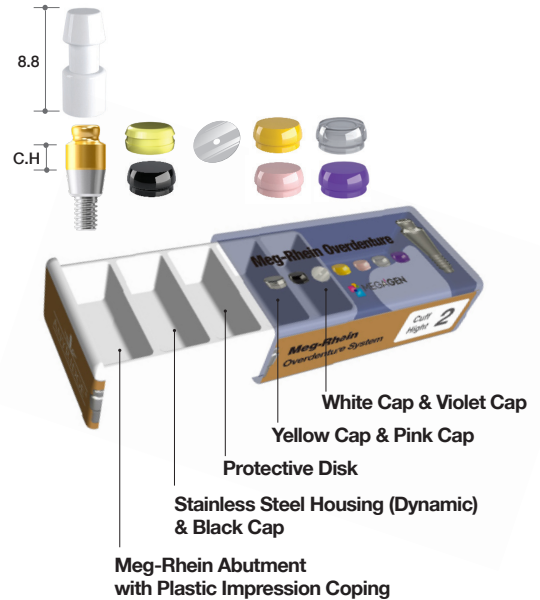

Meg-Rhein Overdenture System

- 1 Meg-Rhein Abutment
- 1 Plastic Impression Coping
- 1 Stainless Steel Housing
- 1 Protective Disk
- 5 Retentive Caps (Black-Lab, Yellow-0.6kgf, Pink-1.2kgf, White-1.8kgf, Violet-2.7kgf)
- Perfect compatibility with the Rhein83 from Italy.
- Recommend torque : 35Ncm.

Cuff Height (mm)	Ref.C
0	IDR00P
2.0	IDR02P
4.0	IDR04P
6.0	IDR06P



➔ Components for Meg-Rhein Abutments

Stainless Steel Housing

• 5ea/pack

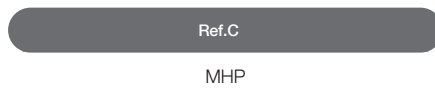

Stainless Steel Housing

(Dynamic)

• 5ea/pack

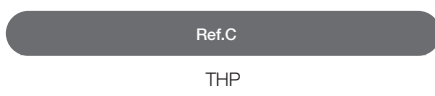

Retentive Caps (White)

- White cap(1.8kgf) - For refill (5ea/pack).
- Can be used for more retentive force following pink cap(1.2kgf).

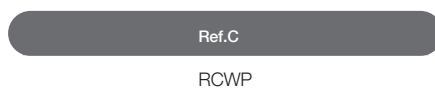

Retentive Caps (Violet)

- Violet cap(2.7kgf) - For refill (5ea/pack).
- Can be used for more retentive force following white cap(1.8kgf).

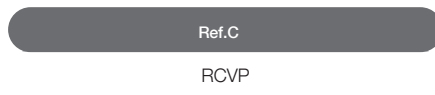

Retentive Caps (Pink)

- Pink cap(1.2kgf) - For refill (5ea/pack).

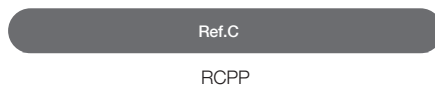

Retentive Caps (Yellow)

- Yellow cap(0.6kgf) - For refill (5ea/pack).

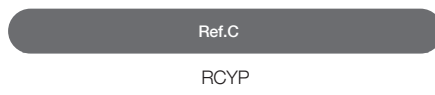

Retentive Caps (Black)

- For laboratory

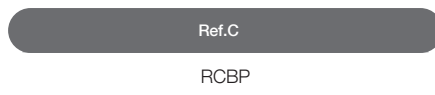

Stainless Impression Coping (Pick-Up)

- 2ea/pack.
- Italy - Rhein 83 products.
- For accurate (pick-up type) impression.
- Metal with groove design to prevent from swaying.

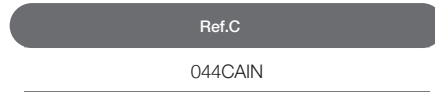

Lab Analog

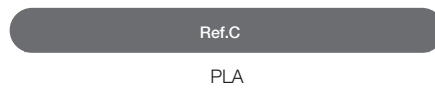

Caps and Clips Extractor tool

- Retentive Cap removal tool.

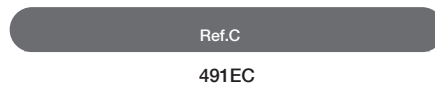

Retentive Cap Insertion Tool

- Retentive Cap insertion tool.

